

# studio

## SETUP GUIDE



YOURS IS HERE



# studio

## SETUP GUIDE

Regulatory model: P02E series

Regulatory type: P02E001; P02E002

# Notes, Cautions, and Warnings



**NOTE:** A NOTE indicates important information that helps you make better use of your computer.



**CAUTION:** A CAUTION indicates either potential damage to hardware or loss of data and tells you how to avoid the problem.



**WARNING:** A WARNING indicates a potential for property damage, personal injury, or death.

---

Information in this document is subject to change without notice.

© 2010 Dell Inc. All rights reserved.

Reproduction of these materials in any manner whatsoever without the written permission of Dell Inc. is strictly forbidden.

Trademarks used in this text: *Dell*, the *DELL* logo, *YOURS IS HERE*, *Solution Station*, and *DellConnect* are trademarks of Dell Inc.; *Intel*, *Pentium*, and *Celeron* are registered trademarks and *Core* is a trademark of Intel Corporation in the U.S. and other countries; *Microsoft*, *Windows*, *Windows Vista*, and the *Windows Vista* start button logo are either trademarks or registered trademarks of Microsoft Corporation in the United States and/or other countries; *Blu-ray Disc* is a trademark of the Blu-ray Disc Association; *Bluetooth* is a registered trademark owned by Bluetooth SIG, Inc. and is used by Dell under license.

Other trademarks and trade names may be used in this document to refer to either the entities claiming the marks and names or their products. Dell Inc. disclaims any proprietary interest in trademarks and trade names other than its own.

March 2010

P/N GYVXH

Rev. A00

# Contents

<b>Setting Up Your Studio Laptop</b> . . . . .	<b>5</b>	Multimedia Controls . . . . .	32
Before Setting Up Your Computer . . . . .	5	Display Features . . . . .	34
Connect the AC Adapter . . . . .	6	Using the Touch Screen (Optional) . . . . .	36
Connect the Network Cable (Optional) . . . . .	7	Removing and Replacing the Battery . . . . .	40
Press the Power Button . . . . .	8	Software Features . . . . .	42
Set Up Microsoft Windows . . . . .	9	Dell DataSafe Online Backup . . . . .	43
Create System Recovery Media (Recommended) . . . . .	10	Dell Dock . . . . .	44
Install the SIM Card (Optional) . . . . .	12	Free Fall Sensor . . . . .	45
Enable or Disable Wireless (Optional) . . . . .	14	<b>Solving Problems</b> . . . . .	<b>46</b>
Connect to the Internet (Optional) . . . . .	16	Touch Screen Problems . . . . .	46
<b>Using Your Studio Laptop</b> . . . . .	<b>20</b>	Touch Screen Calibration . . . . .	47
Right Side Features . . . . .	20	Beep Codes . . . . .	48
Left Side Features . . . . .	24	Network Problems . . . . .	49
Computer Base and Keyboard Features . . . . .	28	Power Problems . . . . .	50
Touch Pad Gestures . . . . .	30	Memory Problems . . . . .	52
		Lockups and Software Problems . . . . .	52

## Contents

<b>Using Support Tools</b> .....	<b>55</b>	Returning Items for Repair Under Warranty or for Credit.....	75
Dell Support Center.....	55	Before You Call.....	76
My Dell Downloads.....	56	Contacting Dell.....	77
System Messages.....	56		
Hardware Troubleshooter.....	58	<b>Finding More Information and Resources</b> .....	<b>78</b>
Dell Diagnostics.....	59		
<b>Restoring Your Operating System</b> .....	<b>63</b>	<b>Specifications</b> .....	<b>80</b>
System Restore.....	64	<b>Appendix</b> .....	<b>93</b>
Dell DataSafe Local Backup.....	65	Macrovision Product Notice.....	93
System Recovery Media.....	67	Information for NOM, or Official Mexican Standard (Only for Mexico).....	94
Dell Factory Image Restore.....	68		
<b>Getting Help</b> .....	<b>71</b>	<b>Index</b> .....	<b>95</b>
Technical Support and Customer Service.....	72		
DellConnect.....	72		
Online Services.....	73		
Automated Order-Status Service.....	74		
Product Information.....	74		

# Setting Up Your Studio Laptop

This section provides information about setting up your Studio 1745/1747/1749 laptop.

## Before Setting Up Your Computer

When positioning your computer, ensure that you allow easy access to a power source, adequate ventilation, and a level surface to place your computer.

Restricting airflow around your laptop may cause it to overheat. To prevent overheating ensure that you leave at least 10.2 cm (4 inches) at the back of the computer and a minimum of 5.1 cm (2 inches) on all other sides. You should never place your computer in an enclosed space, such as a cabinet or drawer when it is powered on.

 **WARNING:** Do not block, push objects into, or allow dust to accumulate in the air vents. Do not place your Dell™ computer in a low-airflow environment, such as a closed briefcase, or on fabric surfaces, such as carpets or rugs, while it is powered on. Restricting the airflow can damage the computer, deteriorate the computer performance, or cause a fire. The computer turns on the fan when the computer gets hot. Fan noise is normal and does not indicate a problem with the fan or the computer.

 **CAUTION:** Placing or stacking heavy or sharp objects on the computer may result in permanent damage to the computer.

## Connect the AC Adapter

Connect the AC adapter to the computer and then plug it into a wall outlet or surge protector.

**⚠ WARNING:** The AC adapter works with electrical outlets worldwide. However, power connectors and power strips vary among countries. Using an incompatible cable or improperly connecting the cable to a power strip or electrical outlet may cause fire or permanent damage to your computer.

**📌 NOTE:** Connect the power cord to the adapter firmly and ensure that the light on the adapter is on when you turn on power.

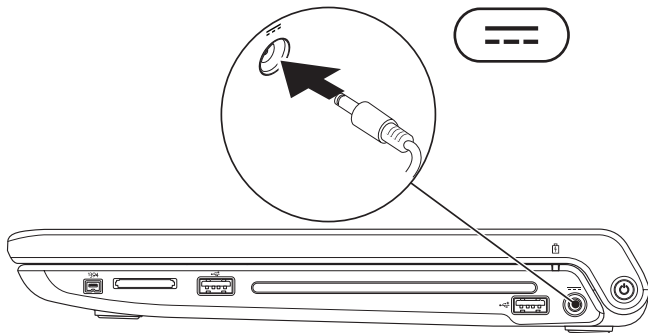











## Set Up Microsoft Windows

Your Dell computer is preconfigured with the Microsoft® Windows® operating system. To set up Microsoft Windows for the first time, follow the instructions on the screen. These steps are mandatory and may take some time to complete. The Windows setup screens will take you through several procedures including accepting license agreements, setting preferences, and setting up an Internet connection.

-  **CAUTION:** Do not interrupt the operating system's setup process. Doing so may render your computer unusable and you will need to reinstall the operating system.
-  **NOTE:** For optimal performance of your computer, it is recommended that you download and install the latest BIOS and drivers for your computer available at [support.dell.com](http://support.dell.com).
-  **NOTE:** For more information on the operating system and features, see [support.dell.com/MyNewDell](http://support.dell.com/MyNewDell).

# Create System Recovery Media (Recommended)

 **NOTE:** It is recommended that you create a system recovery media as soon as you set up Microsoft Windows.

The system recovery media can be used to restore your computer to the operating state it was in when you purchased the computer, while preserving data files (without the need of the *Operating System* disc). You can use the system recovery media if changes to the hardware, software, drivers, or other system settings have left the computer in an undesirable operating state.

You will require the following to create the system recovery media:

- Dell DataSafe Local Backup
- USB key with a minimum capacity of 8 GB or DVD-R/DVD+R/Blu-ray Disc™

 **NOTE:** Dell DataSafe Local Backup does not support rewritable discs.

To create a system recovery media:

1. Ensure that the AC adapter is connected (see “Connect the AC Adapter” on page 6).
2. Insert the disc or USB key in the computer.
3. Click **Start**  → **Programs** → **Dell DataSafe Local Backup**.
4. Click **Create Recovery Media**.
5. Follow the instructions on the screen.

 **NOTE:** For information on using the system recovery media, see “System Recovery Media” on page 67.

# Install the SIM Card (Optional)

 **NOTE:** Installing a SIM card is not required if you are using an EVDO card to access the Internet.

Installing a Subscriber Identity Module (SIM) card on your computer allows you to connect to the Internet. To access the Internet you must be within the network of your cellular service provider.

To install the SIM card:

1. Turn off your computer.
2. Remove the battery (see “Removing and Replacing the Battery” on page 40).
3. In the battery bay, slide the SIM card into the SIM card slot.
4. Replace the battery (see “Removing and Replacing the Battery” on page 40).
5. Turn on your computer.

To remove the SIM card, press and eject the SIM card.

## Setting Up Your Studio Laptop

- 1 SIM card
- 2 SIM card slot
- 3 battery bay

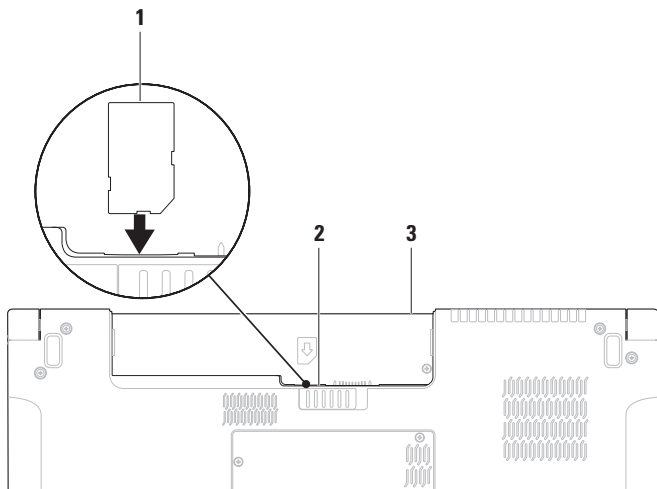

### Enable or Disable Wireless (Optional)

Press the  $\langle \text{A} \rangle$  key or press the  $\langle \text{Fn} \rangle \langle \text{F2} \rangle$  keys on the keyboard to enable or disable wireless. The wireless on or off icons appear on the screen to indicate the status.

Wireless on:

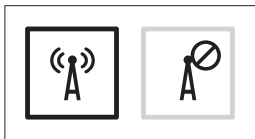

Wireless off:

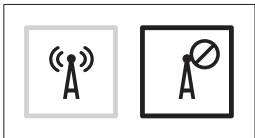

For information on changing the behavior of the Fn key, see “Multimedia Controls” on page 32.



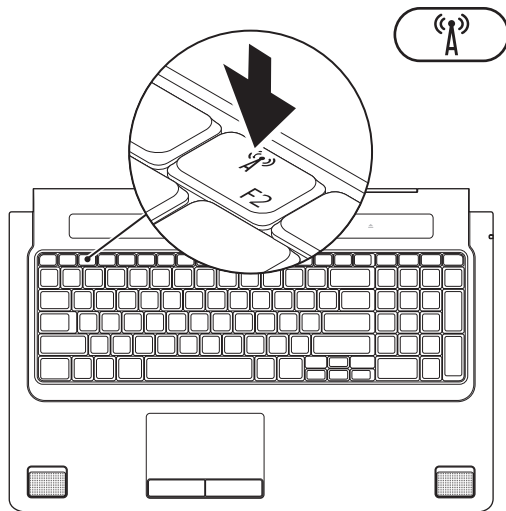

## Connect to the Internet (Optional)

To connect to the Internet, you need an external modem or network connection and an Internet Service Provider (ISP).

If an external USB modem or WLAN adapter is not a part of your original order, you can purchase one at [www.dell.com](http://www.dell.com).

## Setting Up a Wired Connection

- If you are using a dial-up connection, connect the telephone line to the optional external USB modem and to the telephone wall connector before you set up your Internet connection.
- If you are using a DSL or cable/satellite modem connection, contact your ISP or cellular telephone service for setup instructions.

To complete setting up your wired Internet connection, follow the instructions in “Setting Up Your Internet Connection” on page 18.

## Setting Up a Wireless Connection

 **NOTE:** To set up your wireless router, see the documentation that shipped with your router.

Before you can use your wireless Internet connection, you need to connect to your wireless router.

To setup your connection to a wireless router:

*Windows® 7*

1. Ensure that wireless is enabled on your computer (see “Enable or Disable Wireless” on page 14).
2. Save and close any open files, and exit any open programs.
3. Click **Start**  → **Control Panel**.
4. In the search box, type `network`, and then click **Network and Sharing Center** → **Connect to a network**.
5. Follow the instructions on the screen to complete the setup.

*Windows Vista®*

1. Ensure that wireless is enabled on your computer (see “Enable or Disable Wireless” on page 14).
2. Save and close any open files, and exit any open programs.
3. Click **Start**  → **Connect To**.
4. Follow the instructions on the screen to complete the setup.

### Setting Up Your Internet Connection

ISPs and ISP offerings vary by country. Contact your ISP for offerings available in your country.

If you cannot connect to the Internet but have successfully connected in the past, the Internet Service Provider (ISP) might have a service outage. Contact your ISP to check the service status, or try connecting again later.

Have your ISP information ready. If you do not have an ISP, the **Connect to the Internet** wizard can help you get one.

To set up your Internet connection:

#### *Windows 7*

1. Save and close any open files, and exit any open programs.
2. Click **Start**  → **Control Panel**.
3. In the search box, type `network`, and then click **Network and Sharing Center** → **Set up a new connection or network** → **Connect to the Internet**.

The **Connect to the Internet** window appears.

-  **NOTE:** If you do not know which type of connection to select, click **Help me choose** or contact your ISP.
4. Follow the instructions on the screen and use the setup information provided by your ISP to complete the setup.

*Windows Vista*

1. Save and close any open files, and exit any open programs.
2. Click **Start**  → **Control Panel**.
3. In the search box, type `network`, and then click **Network and Sharing Center** → **Set up a connection or network** → **Connect to the Internet**.

The **Connect to the Internet** window appears.

 **NOTE:** If you do not know which type of connection to select, click **Help me choose** or contact your ISP.

4. Follow the instructions on the screen and use the setup information provided by your ISP to complete the setup.

# Using Your Studio Laptop

This section provides information about the features available on your Studio 1745/1747/1749 laptop.

## Right Side Features

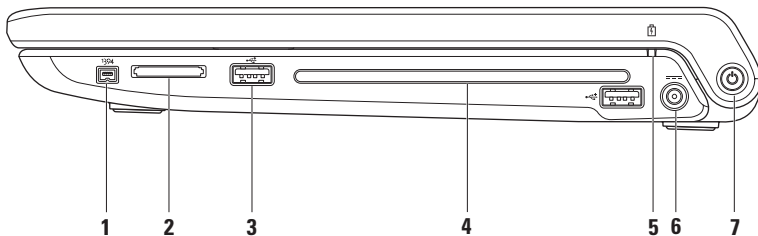

---

**1**  **IEEE 1394a connector** — Connects to high-speed serial multimedia devices, such as digital video cameras.

---

**2 8-in-1 Media Card Reader** — Provides a fast and convenient way to view and share digital photos, music, videos, and documents stored on the following digital memory cards:

- Secure Digital (SD) memory card
- Secure Digital Input/Output (SDIO) card
- Secure Digital High Capacity (SDHC)
- Secure Digital High Density (SDHD)
- Memory Stick
- Memory Stick PRO
- MultiMedia Card (MMC)
- xD-Picture Card

**NOTE:** Your computer ships with a plastic blank installed in the media card slot. Blanks protect unused slots from dust and other particles. Save the blank for use when no media card is installed in the slot; blanks from other computers may not fit your computer.

---

**3**  **USB 2.0 connectors (2)** — Connect to USB devices, such as a mouse, keyboard, printer, external drive, or MP3 player.

---

- 4 Optical drive** — Plays or records CDs, DVDs, and Blu-ray Discs (optional). Ensure that you insert the disc with the printed side facing upwards.

 **CAUTION:** Do not use non-standard size or shape discs (including mini-CDs and mini-DVDs) or you will damage the drive.

Place the disc in the center of the disc slot, with the label facing upwards and gently push the disc into the slot. The drive will automatically pull the disc in and begin reading its content.

---

- 5  Battery status light** — Turns on steadily or blinks to indicate the battery charge status. The light indicates the following states when the computer is powered by the AC adapter:

- Off — the battery is adequately charged or the computer is turned off.
- Solid white — the battery is charging.
- Solid amber — the battery charge is low and the battery is charging.

the battery:

- Off — the battery is not charging.
  - Solid amber — the battery charge is low and you should either plug in the AC adapter or save and close your open documents and applications.
-



**6**  **AC adapter connector** — Connects to the AC adapter to power the computer and charge the battery.

---

**7**  **Power button and light** — Turns the computer on or off when pressed.

The light in the button indicates the following power states:

- Solid white — The computer is on.
  - Blinking white — The computer is in standby mode.
  - Off — The computer is off or in hibernate state.
-

## Left Side Features

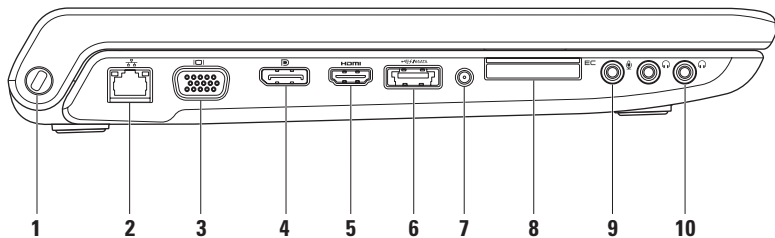

- 
- 1 Security cable slot** — Attaches a commercially available security cable to the computer.

**NOTE:** Before you buy a security cable, ensure that it fits into the security cable slot on your computer.

---

- 2**  **Network connector** — Connects your computer to a network or a broadband device if you are using a wired network. The two lights next to the connector indicate the status and activity for a wired network connection.
- 

- 3**  **VGA connector** — Connects to video devices, such as a monitor or a projector.
- 

- 4**  **DisplayPort connector** — Digital interface standard connector that supports external DisplayPort monitors and projectors.
- 

- 5**  **HDMI connector** — Connects to a TV for both 5.1 audio and video signals.

**NOTE:** When used with a monitor, only the video signal is read.

---



- 6**  **eSATA/USB combo connector with USB PowerShare** — Connects to eSATA compatible storage devices (such as external hard drives or optical drives) or USB devices (such as a mouse, keyboard, printer, external drive, or MP3 player). The USB PowerShare feature allows you to charge USB devices when the computer is powered on/off or in sleep state.

**NOTE:** Certain USB devices may not charge when the computer is powered off or in sleep state. In such cases, turn on the computer to charge the device.

**NOTE:** If you turn off your computer while charging a USB device, the device will stop charging. To continue charging, disconnect the USB device and connect it again.

**NOTE:** The USB PowerShare is automatically shut off when only 10% of the total battery life remains.

- 
- 7** **Antenna in connector (on supported models)** — Connects to an external antenna to view programs using the TV tuner card (optional).
-

- 
- 8  **ExpressCard slot** — Provides support for additional memory, wired and wireless communications, multimedia, and security features. The slot supports 34 mm ExpressCards.  
**NOTE:** The ExpressCard slot is designed only for ExpressCards. It does NOT support PC cards.  
**NOTE:** Your computer ships with a plastic blank installed in the ExpressCard slot. Blanks protect unused slots from dust and other particles. Save the blank for use when no ExpressCard is installed in the slot; blanks from other computers may not fit your computer.
- 
- 9  **Audio in/Microphone connector** — Connects to a microphone or inputs signal for use with audio programs.
- 
- 10  **Audio out/Headphone connectors (2)** — Connect one or two pairs of headphones, or sends audio to a powered speaker or sound system. The audio signal is the same for both connectors.
-

## Computer Base and Keyboard Features

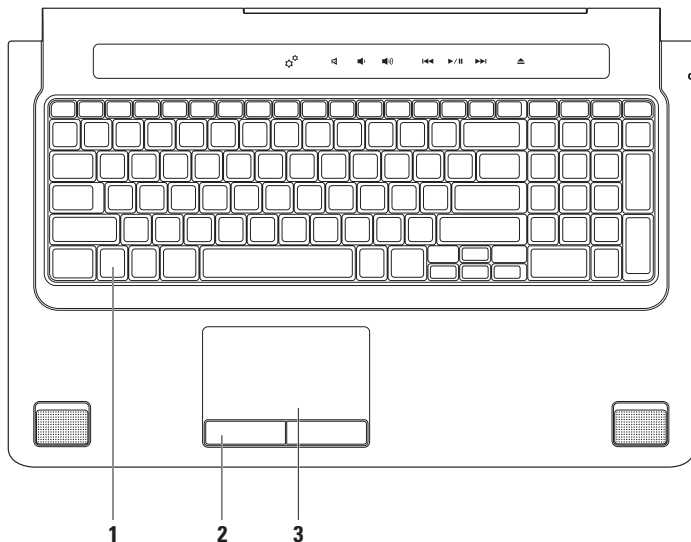

- 
- 1 Keyboard/Backlit Keyboard (optional)** — If you have purchased the optional backlit keyboard, the F6 key has the backlit keyboard icon  on it. The optional backlit keyboard provides visibility in dark environments by illuminating all symbols on the keys.

The multimedia control keys are also located on the keyboard. These keys control CD, DVD, Blu-ray Disc™ (optional), and media playback.

 **Backlit keyboard brightness settings** — Press the <F6> key to toggle the three lighting states (in the given order):

- a. half keyboard brightness
- b. full keyboard brightness
- c. no lighting

For more information about the keyboard, see the *Dell Technology Guide*.

- 
- 2 Touch pad buttons** — Provide left-click and right-click functions like those on a mouse.

- 
- 3 Touch pad** — Provides the functionality of a mouse to move the cursor, drag or move selected items, and left-click by tapping the surface.

The touch pad supports the Scroll, Flick, Zoom, and Rotate features. To change the touch pad settings, double-click the **Synaptics Pointing Device** icon in the notification area of the desktop.

---

## Touch Pad Gestures

 **NOTE:** Some of the touch pad gestures may be disabled by default. To change the touch pad gestures settings, double-click the **Synaptics Pointing Device** icon in the notification area of your desktop.

### Two-Finger Gestures

**Scroll** — Allows you to scroll through content. The scroll feature includes:

**Auto Scroll Vertical** — Allows you to scroll up or down on the active window.

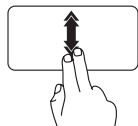

Move two fingers up or down at a fast pace to activate vertical auto scrolling.

Tap on the touch pad to stop auto scrolling.

**Auto Scroll Horizontal** — Allows you to scroll left or right on the active window.

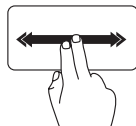

Move two fingers to your left or right at a fast pace to activate horizontal auto scrolling.

Tap on the touch pad to stop auto scrolling.

**Zoom** — Allows you to increase or decrease the magnification of the screen content. The zoom feature includes:

**Pinch** — Allows you to zoom-in or zoom-out by moving two fingers apart or bringing them closer together on the touch pad.

To zoom in:

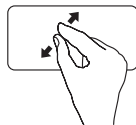

Move two fingers apart to enlarge the view of the active window.



To zoom out:

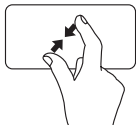

Move two fingers close together to reduce the view of the active window.

**Rotate** — Allows you to rotate the active content on the screen. The rotate feature includes:

**Twist** — Allows you to rotate active content using two fingers where one finger is anchored and the other rotates.

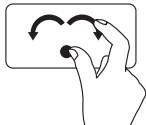

Keeping the thumb in place, move the index finger in an arced direction right or left to rotate the selected item clockwise or counterclockwise.

## Three-Finger Gesture

**Flick** — Allows you to flip content forward or backward based on the direction of the flick.

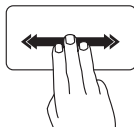

Move three fingers quickly in the desired direction to flip content in the active window.

# Multimedia Controls

The multimedia controls can be accessed using the multimedia control keys on the keyboard or the touch-sensitive multimedia controls located above the keyboard.

## Multimedia Control Keys

You can configure the multimedia control keys on the keyboard using the **System Setup** (BIOS) Utility or the **Windows Mobility Center**.

### System Setup (BIOS) Utility

To access the **Function Key Behavior**:

1. Press <F2> during POST (Power On Self Test) to enter the **System Setup** (BIOS) utility.
2. In the **Function Key Behavior**, select **Multimedia Key First** or **Function Key First**.



**Multimedia Key First** — This is the default option. Press any multimedia key to perform the associated action. For function key, press <Fn> + the required function key.

**Function Key First** — Press any function key to perform the associated action.

For multimedia key, press <Fn> + the required multimedia key.

 **NOTE:** The **Multimedia Key First** option is active only in the operating system.

## Windows Mobility Center

1. Press the <  > <X> keys on the keyboard or touch the  icon on the touch-sensitive multimedia controls to launch the Windows Mobility Center.
2. In the **Function Key Row**, select **Function Key** or **Multimedia Key**.

## Touch-Sensitive Multimedia Controls

Touching the multimedia control performs the associated multimedia action.

## Multimedia Control Keys





## Touch-Sensitive Multimedia Controls



 Launch Windows Mobility Center

 Mute the sound

 Decrease the volume level

 Increase the volume level

 Play the previous track or chapter

 Play or pause

 Play the next track or chapter

 Eject the disc

## Display Features

The display panel holds a camera and accompanying dual microphones.

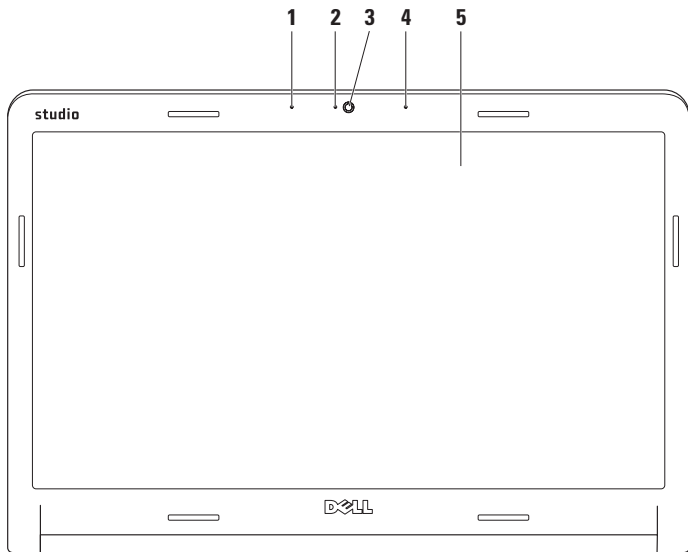

- 
- 1 Left digital array microphone** — Combines with the right digital array microphone to provide high-quality sound for video chatting and voice recording.
  - 2 Camera activity indicator** — Indicates if the camera is on or off.
  - 3 Camera** — Built-in camera for video capture, conferencing, and chat.
  - 4 Right digital array microphone** — Combines with the left digital array microphone to provide high-quality sound for video chatting and voice recording.
  - 5 Display** — Your display can vary based on selections you made when purchasing your computer. For more information about displays, see the *Dell Technology Guide* on your hard drive or at [support.dell.com/manuals](http://support.dell.com/manuals).
-

# Using the Touch Screen (Optional)

The touch screen feature on your laptop converts your computer into an interactive display.

## Dell Touch Zone

To launch the Dell Touch Zone software click **Start**  → **All Programs** → **Dell** → **Dell Touch Zone**.

You can access the following features in the Dell Touch Zone software:

- **Picture Viewer** — View, organize, and edit pictures.
- **Dell Touch Cam** — Capture home videos with the built-in camera. You can upload videos to **YouTube** when connected to the Internet.

- **Notes Creator** — Create typed or handwritten reminders. These notes will appear on the bulletin board the next time you access Dell Touch Zone.
- **Drum Zone** — Play a game to the music on your computer or play synthesized percussion instruments.
- **You Paint** — Draw, paint images, and edit photographs using this software.
- **Games** — Play select Windows games using touch.
- **Music** — Play music, create playlists, and browse through your music files by album, artist, or song title.

- Internet Explorer — Browse the Internet using multi-touch technology. Touch a link you want to follow or download.
- Help — Use the Help feature for more information on how to use the touch screen.

A video highlighting the features of the touch screen launches the first time your computer starts up.

### Touch Screen Gestures (Optional)

 **NOTE:** Some of these gestures may not work outside the Dell Touch Zone software.

#### Zoom

Allows you to increase or decrease the magnification of the screen content.

**Pinch** — Allows you to zoom-in or zoom-out by moving two fingers apart or bringing them closer together on the screen.



*To zoom in:* Move two fingers apart to enlarge the view of the active window.



*To zoom out:* Move two fingers close together to reduce the view of the active window.

#### Dwell

Allows you to access additional information by simulating a right-click.

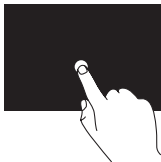

Press and hold a finger on the touch screen, to open context-sensitive menus.

#### Flick

Allows you to flip content forward or backward based on the direction of the flick.

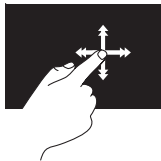

Move a finger quickly in the desired direction to flip through content in the active window like pages in a book. Flick also works vertically when navigating content such as images or songs in a playlist.



## Scroll

Allows you to scroll through content. The scroll features include:

**Pan** — Allows you to move the focus on the selected object when the entire object is not visible.

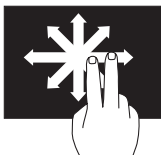

Move two fingers in the desired direction to pan scroll the selected object.

**Scroll Vertical** — Allows you to scroll up or scroll down on the active window.

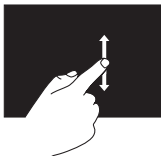

Move a finger up or down to activate vertical scrolling.

**Scroll Horizontal** — Allows you to scroll left or right on the active window.

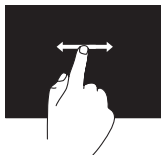

Move a finger to the left or right to activate horizontal scrolling.

## Rotate

Allows you to rotate the active content on the screen.

**Twist** — Allows you to rotate the active content using two fingers.



Keeping a finger or thumb in place, move the other finger in an arced direction right or left. You can also rotate the active content by moving both the fingers in a circular motion.

## Removing and Replacing the Battery

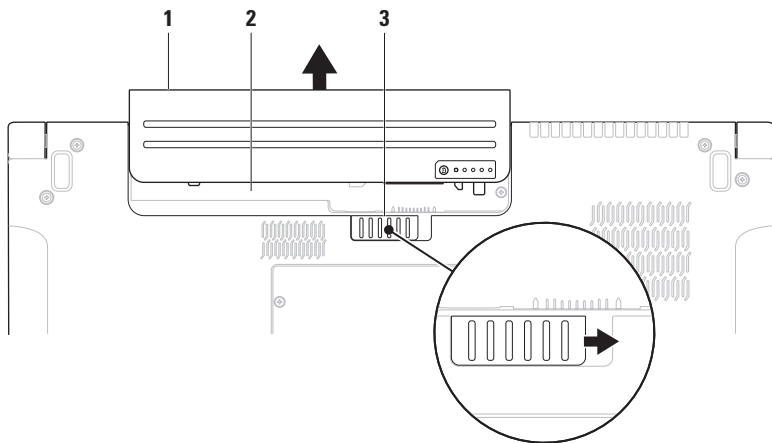

- 
- 1** battery
- 
- 2** battery bay
- 
- 3** battery release latch
-

 **WARNING: Using an incompatible battery may increase the risk of fire or explosion. This computer should only use a battery purchased from Dell. Do not use batteries from other computers.**

 **WARNING: Before removing the battery, shut down the computer, and remove external cables (including the AC adapter).**

To remove the battery:

1. Shut down the computer and turn it over.
2. Slide the battery release latch to the side.
3. Slide the battery away from the battery bay.

To replace the battery:

Slide the battery into the battery bay, until it clicks into place.

## Software Features

 **NOTE:** For more information about the features described in this section, see the *Dell Technology Guide* on your hard drive or at [support.dell.com/manuals](http://support.dell.com/manuals).

### FastAccess Facial Recognition

Your computer may have the FastAccess facial recognition feature. This feature helps keep your Dell computer secure by using the unique appearance of your face to verify your identity and automatically supply login information that you would normally enter manually, such as a user ID and password for a Windows account or a secure web site. For more information, click **Start**  → **Programs** → **FastAccess**.

## Productivity and Communication

You can use your computer to create presentations, brochures, greeting cards, fliers, and spreadsheets. You can also edit and view digital photographs and images. Check your purchase order for software installed on your computer.

After connecting to the Internet, you can access websites, setup an e-mail account, upload or download files, and so on.

## Entertainment and Multimedia

You can use your computer to watch videos, play games, create your own CDs/DVDs, listen to music and internet radio stations. Your optical drive may support multiple disc media formats including CDs, DVDs, and Blu-ray Discs (optional).

You can download or copy pictures and video files from portable devices, such as digital cameras and cell phones. Optional software applications enable you to organize and create music and video files that can be recorded to disc, saved on portable products such as MP3 players and handheld entertainment devices, or played and viewed directly on connected TVs, projectors, and home theater equipment.

## Dell DataSafe Online Backup

 **NOTE:** Dell DataSafe Online may not be available in all regions.

 **NOTE:** A broadband connection is recommended for fast upload/download speeds.

Dell DataSafe Online is an automated backup and recovery service that helps protect your data and other important files from catastrophic incidents like theft, fire, or natural disasters. You can access the service on your computer using a password-protected account.

For more information, go to **[delldatasafe.com](http://delldatasafe.com)**.

To schedule backups:

1. Double-click the Dell DataSafe Online icon  on the taskbar.
2. Follow the instructions that appear on the screen.

# Dell Dock

The Dell Dock is a group of icons that provides easy access to frequently-used applications, files, and folders. You can personalize the Dock by:

- Adding or removing icons
- Changing the color and location of the Dock
- Grouping related icons into categories
- Changing the behavior of the icons



## Add a Category

1. Right-click the Dock, click **Add**→ **Category**. The **Add/Edit Category** window appears.
2. Enter a title for the category in the **Title** field.
3. Select an icon for the category from the **Select an image:** box.
4. Click **Save**.

## Add an Icon

Drag and drop the icon to the Dock or a category.

## Remove a Category or Icon

1. Right-click the category or icon on the Dock and click **Delete shortcut** or **Delete category**.
2. Follow the instructions on the screen.

## Personalize the Dock

1. Right-click the Dock and click **Advanced Setting....**
2. Choose the desired option to personalize the Dock.

## Free Fall Sensor

Free fall sensor protects your computer hard drive from possible damage, by detecting a free fall state caused by accidentally dropping the computer. When a free fall state is detected, the hard drive is placed in a *safe state* to protect against damage to the read/write head and possible data loss. Your hard drive returns to normal operation, when the free fall state is no longer detected.

# Solving Problems

This section provides troubleshooting information for your computer. If you cannot solve your problem using the following guidelines, see “Using Support Tools” on page 55 or “Contacting Dell” on page 77.

 **WARNING:** Only trained service personnel should remove the computer cover. See the *Service Manual* at [support.dell.com/manuals](http://support.dell.com/manuals) for advanced service and troubleshooting instructions.

 **WARNING:** Before working inside your computer, read the safety information that shipped with your computer. For additional safety best practice information, see the Regulatory Compliance Homepage at [www.dell.com/regulatory\\_compliance](http://www.dell.com/regulatory_compliance).

## Touch Screen Problems

**Some or all multi-touch features are not working** —

- Certain touch screen features may be disabled. To enable the touch screen features, click **Start**  → **Control Panel** → **Hardware and Sound** → **Pen and Input Devices**.
- The multi-touch feature may not be supported by the application.



### If the touch screen starts losing its sensitivity —

- Calibrate the touch screen (see “Touch Screen Calibration” on page 47)
- The touch screen may have foreign particles (such as sticky notes) that are blocking the touch sensors. To remove these particles:
  - a. Turn off the computer.
  - b. Disconnect the power cord from the wall outlet.

 **CAUTION: Do not use water or a cleaning liquid to wipe the touch screen.**

- c. Use a clean, lint-free cloth (can spray mild water on cloth if needed, but not on the screen) and wipe the surface and sides of the touch screen to remove any dirt or fingerprints.

## Touch Screen Calibration

 **NOTE:** It is recommended that you calibrate the touch screen if you have touch screen problems or if you change the screen resolution.

To calibrate the touch screen:

1. Click **Start**  → **Control Panel** → **Hardware and Sound** → **N-trig DuoSense™ Digitizer Settings**.

2. Click **Start**.

 **NOTE:** Do not touch the screen until the calibration is complete.

3. Follow the instructions on the screen.

# Beep Codes

Your computer might emit a series of beeps during start-up if there are errors or problems. This series of beeps, called a beep code, identifies a problem. If this occurs, write down the beep code and contact Dell (see “Contacting Dell” on page 77).

 **NOTE:** To replace parts, see the *Service Manual* at [support.dell.com/manuals](http://support.dell.com/manuals).

Beep Code	Possible Problem
One	Possible system board failure — BIOS ROM checksum failure
Two	No RAM detected <b>NOTE:</b> If you installed or replaced the memory module, ensure that the memory module is seated properly.
Three	Possible system board failure — Chipset error
Four	RAM read/write failure
Five	Real Time Clock failure
Six	Video card or chip failure
Seven	Processor failure
Eight	Display failure

## Network Problems

### Wireless Connections

#### **If the wireless network connection is lost** —

The wireless router is offline or wireless has been disabled on the computer.

- Check your wireless router to ensure it is powered on and connected to your data source (cable modem or network hub).
- Ensure that wireless is enabled on your computer (see “Enable or Disable Wireless” on page 14).
- Re-establish your connection to the wireless router (see “Setting Up a Wireless Connection” on page 17).
- Interference may be blocking or interrupting your wireless connection. Try moving the computer closer to your wireless router.

### Wired Connections

**If the wired network connection is lost** — The cable is loose or damaged.

- Check the cable to ensure it is plugged in and not damaged.
- The link integrity light on the integrated network connector lets you verify that your connection is working and provides information on the status:
  - Green (right) — A good connection exists between a 10-Mbps network and the computer.
  - Yellow (right) — A good connection exists between a 100-Mbps network and the computer.

## Solving Problems

- Orange (right) — A good connection exists between a 1000-Mbps network and the computer.
- Blinking yellow (left) — A network traffic exists.
- Off — The computer is not detecting a physical connection to the network.

 **NOTE:** The link integrity light on the network connector is only for the wired network connection. The link integrity light does not provide status for wireless connections.

## Power Problems

**If the power light is off** — The computer is either turned off or is not receiving power.

- Press the power button. The computer resumes normal operation if it is off or in hibernate mode.
- Reseat the AC adapter cable into the power connector on the computer and the electrical outlet.
- If the computer is plugged into a power strip, ensure that the power strip is plugged into an electrical outlet and that the power strip is turned on.
- Temporarily bypass power protection devices, power strips, and power extension cables to verify that the computer turns on properly.
- Ensure that the electrical outlet is working by testing it with another device, such as a lamp.

- Check the AC adapter cable connections. If the AC adapter has a light, ensure that the light on the AC adapter is on.

**If the power light is solid white and the computer is not responding** — The display may not be responding.

- Press the power button until the computer turns off and then turn it back on.
- If the problem persists, contact Dell (see “Contacting Dell” on page 77).

**If the power light is blinking white** — The computer is in standby state or the display may not be responding.

- Press a key on the keyboard, move the connected mouse or a finger on the touch pad, or press the power button to resume normal operation.
- If the display is not responding, press the power button until the computer turns off and then turn it back on.

- If the problem persists, contact Dell (see “Contacting Dell” on page 77).

**If you encounter interference that hinders reception on your computer** — An unwanted signal is creating interference by interrupting or blocking other signals. Some possible causes of interference are:

- Power, keyboard, and mouse extension cables.
- Too many devices connected to a power strip.
- Multiple power strips connected to the same electrical outlet.

## Memory Problems

**If you receive an insufficient memory message** —

- Save and close any open files and exit any open programs you are not using to see if that resolves the problem.
- See the software documentation for minimum memory requirements. If necessary, install additional memory (see the *Service Manual* at [support.dell.com/manuals](http://support.dell.com/manuals)).
- Reseat the memory module(s) into the connector(s) (see the *Service Manual* at [support.dell.com/manuals](http://support.dell.com/manuals) for instructions).
- If the problem persists, contact Dell (see “Contacting Dell” on page 77).

**If you experience other memory problems** —

- Run the Dell Diagnostics (see “Dell Diagnostics” on page 59).
- If the problem persists, contact Dell (see “Contacting Dell” on page 77).

## Lockups and Software Problems

**If the computer does not start up** — Ensure that the power cable is firmly connected to the computer and to the electrical outlet.

**If a program stops responding** —

End the program:

1. Press <Ctrl><Shift><Esc> simultaneously.
2. Click **Applications**.
3. Click the program that is no longer responding
4. Click **End Task**.

**If a program crashes repeatedly** — Check the software documentation. If necessary, uninstall and then reinstall the program.



**NOTE:** Software usually includes installation instructions in its documentation or on the CD.

**If the computer stops responding or a solid blue screen appears —**

 **CAUTION: You might lose data if you are unable to perform an operating system shutdown.**

If you are unable to get a response by pressing a key on your keyboard or moving your mouse, press the power button for at least 8 to 10 seconds until the computer turns off and then restart your computer.

**If a program is designed for an earlier Microsoft® Windows® operating system —**

Run the Program Compatibility Wizard. The Program Compatibility Wizard configures a program so that it runs in an environment similar to an earlier version of Microsoft Windows operating system environments.

To run the Program Compatibility Wizard:  
*Windows 7*

1. Click **Start**  → **Control Panel** → **Programs** → **Run programs made for previous versions of Windows.**
2. In the welcome screen, click **Next.**
3. Follow the instructions on the screen.

*Windows Vista*

1. Click **Start**  → **Control Panel** → **Programs** → **Use an older program with this version of Windows.**
2. In the welcome screen, click **Next.**
3. Follow the instructions on the screen.

## Solving Problems

### If you have other software problems —

- Back up your files immediately.
- Use a virus-scanning program to check the hard drive or CDs.
- Save and close any open files or programs and shut down your computer through the **Start**  menu.
- Check the software documentation or contact the software manufacturer for troubleshooting information:
  - Ensure that the program is compatible with the operating system installed on your computer.
  - Ensure that your computer meets the minimum hardware requirements needed to run the software. See the software documentation for information.
  - Ensure that the program is installed and configured properly.
  - Verify that the device drivers do not conflict with the program.
  - If necessary, uninstall and then reinstall the program.



# Using Support Tools

## Dell Support Center

The **Dell Support Center** helps you find the service, support, and system-specific information you need.

To launch the application, click the  icon in the taskbar.

The **Dell Support Center** home page displays your computer's model number, service tag, express service code, and service contact information.

The home page also provides links to access:

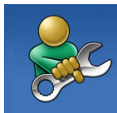

**Self Help** (Troubleshooting, Security, System Performance, Network/Internet, Backup/Recovery, and Windows operating system)



**Alerts** (technical support alerts relevant to your computer)



**Assistance from Dell** (Technical Support with DellConnect™, Customer Service, Training and Tutorials, How-To Help with Solution Station™, and Online Scan with PC CheckUp)



**About Your System** (System Documentation, Warranty Information, System Information, Upgrades & Accessories)

For more information about **Dell Support Center** and available support tools, click the **Services** tab at [support.dell.com](http://support.dell.com).

### My Dell Downloads

 **NOTE:** My Dell Downloads may not be available in all regions.

Some of the software pre-installed on your new computer do not include a backup CD or DVD. This software is available at My Dell Downloads. From this website you can download available software for reinstallation or create your own backup media.

To register and use My Dell Downloads:

1. Go to **downloadstore.dell.com/media**.
2. Follow the instructions on the screen to register and download the software.
3. Reinstall or create backup media of the software for future use.

### System Messages

If your computer has an issue or error, it may display a System Message that will help you identify the cause and action needed to resolve the issue.

 **NOTE:** If the message you received is not listed in the following examples, see the documentation for either the operating system or the program that was running when the message appeared. Alternatively you could see the *Dell Technology Guide* on your hard drive or at **support.dell.com/manuals** or contact Dell (see “Contacting Dell” on page 77).

**Alert! Previous attempts at booting this system have failed at checkpoint [nnnn]. For help in resolving this problem, please note this checkpoint and contact Dell Technical Support** — The computer failed to complete the boot routine three consecutive times for the same error. Contact Dell (see “Contacting Dell” on page 77).

**CMOS checksum error** — Possible system board failure or RTC battery low. Replace the battery (see the *Service Manual* at [support.dell.com/manuals](http://support.dell.com/manuals)) or contact Dell (see “Contacting Dell” on page 77).

**CPU fan failure** — CPU fan has failed. Replace the CPU fan (see the *Service Manual* at [support.dell.com/manuals](http://support.dell.com/manuals)).

**Hard-disk drive failure** — Possible hard-disk drive failure during POST. Contact Dell (see “Contacting Dell” on page 77).

**Hard-disk drive read failure** — Possible hard-disk drive failure during HDD boot test. Contact Dell (see “Contacting Dell” on page 77).

**Keyboard failure** — Keyboard failure or loose cable.

To replace the keyboard, see the *Service Manual* at [support.dell.com/manuals](http://support.dell.com/manuals).

**No boot device available** — No bootable partition on hard drive, the hard drive cable is loose, or no bootable device exists.

- If the hard drive is your boot device, ensure that the cables are connected and that the drive is installed properly and partitioned as a boot device.
- Enter system setup and ensure that the boot sequence information is correct (see the *Dell Technology Guide* at [support.dell.com/manuals](http://support.dell.com/manuals)).

**No timer tick interrupt** — A chip on the system board might be malfunctioning or system board failure. Contact Dell (see “Contacting Dell” on page 77).

## Using Support Tools

**USB over current error** — Disconnect the USB device. Your USB device needs more power for it to function properly. Use an external power source to connect the USB device, or if your device has two USB cables, connect both of them.

**CAUTION - Hard Drive SELF MONITORING SYSTEM has reported that a parameter has exceeded its normal operating range. Dell recommends that you back up your data regularly. A parameter out of range may or may not indicate a potential hard drive problem** — S.M.A.R.T error, possible hard drive failure. Contact Dell (see “Contacting Dell” on page 77).

## Hardware Troubleshooter

If a device is either not detected during the operating system setup or is detected but incorrectly configured, you can use the **Hardware Troubleshooter** to resolve the incompatibility.

To start the Hardware Troubleshooter:

1. Click **Start**  → **Help and Support**.
2. Type `hardware troubleshooter` in the search field and press <Enter> to start the search.
3. In the search results, select the option that best describes the problem and follow the remaining troubleshooting steps.

## Dell Diagnostics

If you experience a problem with your computer, perform the checks in “Lockups and Software Problems” on page 52 and run the Dell Diagnostics before you contact Dell for technical assistance. It is recommended that you print these procedures before you begin.

 **NOTE:** Dell Diagnostics works only on Dell computers.

 **NOTE:** The *Drivers and Utilities* disc may not ship with your computer.

See the *Specifications* on page 80 to review your computer’s configuration information, and ensure that the device that you want to test appears in the system setup program and is active.

Start the Dell Diagnostics from your hard drive or from the *Drivers and Utilities* disc.



## Starting Dell Diagnostics From Your Hard Drive

The Dell Diagnostics is located on a hidden diagnostic utility partition on your hard drive.

 **NOTE:** If your computer cannot display a screen image, contact Dell (see “Contacting Dell” on page 77).

1. Ensure that the computer is connected to an electrical outlet that is known to be working properly.
2. Turn on (or restart) your computer.
3. When the DELL™ logo appears, press <F12> immediately. Select **Diagnostics** from the boot menu and press <Enter>. This may invoke the Pre-Boot System Assessment (PSA) on your computer.

## Using Support Tools

-  **NOTE:** If you wait too long and the operating system logo appears, continue to wait until you see the Microsoft® Windows® desktop; then, shut down your computer and try again.
-  **NOTE:** If you see a message stating that no diagnostic utility partition has been found, run the Dell Diagnostics from the *Drivers and Utilities* disc.

*If PSA is invoked:*

- a. The PSA will start running the tests.
- b. If the PSA completes successfully, the following message is displayed: "No problems have been found with this system so far. Do you want to run the remaining memory tests? This will take about 30 minutes or more. Do you want to continue? (Recommended)."

- c. If you are experiencing memory issues press <y>, otherwise press <n>. The following message is displayed: "Booting Dell Diagnostic Utility Partition. Press any key to continue."
- d. Press any key to go to the **Choose An Option** window.



*If PSA is not invoked:*

Press any key to start the Dell Diagnostics from the diagnostics utility partition on your hard drive and to go to the **Choose An Option** window.

4. Select the test you want to run.
5. If a problem is encountered during a test, a message appears with an error code and a description of the problem. Write down the error code and problem description and contact Dell (see "Contacting Dell" on page 77).

-  **NOTE:** The Service Tag for your computer is displayed at the top of each test screen. The Service Tag helps you identify your computer when you contact Dell.
6. When the tests are complete, close the test screen to return to the **Choose An Option** window.
  7. To exit the Dell Diagnostics and to restart the computer, click **Exit**.

## Starting Dell Diagnostics From the Drivers and Utilities Disc

-  **NOTE:** The *Drivers and Utilities* disc may not ship with your computer.
1. Insert the *Drivers and Utilities* disc.
  2. Shut down and restart the computer. When the DELL logo appears, press <F12> immediately.
-  **NOTE:** If you wait too long and the operating system logo appears, continue to wait until you see the Microsoft® Windows® desktop; then, shut down your computer and try again.
-  **NOTE:** The next steps change the boot sequence for one time only. On the next start-up, the computer boots according to the devices specified in the system setup program.
3. When the boot device list appears, highlight **CD/DVD/CD-RW** and press <Enter>.

## Using Support Tools

4. Select the **Boot from CD-ROM** option from the menu that appears and press <Enter>.
  5. Type **1** to start the CD menu and press <Enter> to proceed.
  6. Select **Run the 32 Bit Dell Diagnostics** from the numbered list. If multiple versions are listed, select the version appropriate for your computer.
  7. Select the test you want to run.
  8. If a problem is encountered during a test, a message appears with an error code and a description of the problem. Write down the error code and problem description and contact Dell (see “Contacting Dell” on page 77).
-  **NOTE:** The Service Tag for your computer is displayed at the top of each test screen. The Service Tag helps you identify your computer when you contact Dell.
9. When the tests are complete, close the test screen to return to the **Choose An Option** window.
  10. To exit the Dell Diagnostics and restart the computer, click **Exit**.
  11. Remove the *Drivers and Utilities* disc.



# Restoring Your Operating System

You can restore the operating system on your computer using any of the following options:

 **CAUTION:** Using Dell Factory Image Restore or the *Operating System* disc permanently deletes all data files on your computer. If possible, backup your data files before using these options.

Option	Use
System Restore	as the first solution
Dell DataSafe Local Backup	when System Restore does not resolve your problem
System recovery media	when operating system failure prevents the use of System Restore and DataSafe Local Backup when installing the factory image on a newly installed hard drive
Dell Factory Image Restore	to restore your computer to the operating state it was in when you received your computer
<i>Operating System</i> disc	to reinstall only the operating system on your computer

 **NOTE:** The *Operating System* disc may not ship with your computer.

# System Restore

The Windows operating systems provide a System Restore option which allows you to return your computer to an earlier operating state (without affecting data files) if changes to the hardware, software, or other system settings have left the computer in an undesirable operating state. Any changes that System Restore makes to your computer are completely reversible.

 **CAUTION: Make regular backups of your data files. System Restore does not monitor your data files or recover them.**

## Starting System Restore

1. Click **Start** .
2. In the search box, type `System Restore` and press <Enter>.

 **NOTE:** The **User Account Control** window may appear. If you are an administrator on the computer, click **Continue**; otherwise, contact your administrator to continue the desired action.

3. Click **Next** and follow the instructions on the screen.

In the event that System Restore did not resolve the issue, you may undo the last system restore.

## Undoing the Last System Restore

 **NOTE:** Before you undo the last system restore, save and close all open files and exit any open programs. Do not alter, open, or delete any files or programs until the system restoration is complete.

1. Click **Start** .
2. In the search box, type `System Restore` and press <Enter>.
3. Click **Undo my last restoration**, click **Next** and follow the instructions on the screen.

## Dell DataSafe Local Backup

 **CAUTION:** Using Dell DataSafe Local Backup permanently removes any programs or drivers installed after you received your computer. Prepare backup media of applications you need to install on your computer before using Dell DataSafe Local Backup. Use Dell DataSafe Local Backup only if System Restore did not resolve your operating system problem.

 **CAUTION:** Although Dell Datasafe Local Backup is designed to preserve the data files on your computer, it is recommended that you backup your data files before using Dell DataSafe Local Backup.

 **NOTE:** Dell DataSafe Local Backup may not be available in all regions.

 **NOTE:** If Dell DataSafe Local Backup is not available on your computer, use Dell Factory Image Restore (see “Dell Factory Image Restore” on page 68) to restore your operating system.

## Restoring Your Operating System

You can use Dell DataSafe Local Backup to restore your hard drive to the operating state it was in when you purchased your computer, while preserving the data files.

Dell DataSafe Local Backup allows you to:

- Backup and restore your computer to an earlier operating state
- Create system recovery media

### Dell DataSafe Local Backup Basic

To restore the factory image while preserving the data files:

1. Turn off your computer.
2. Disconnect all the devices (USB drive, printer, etc.) connected to the computer and remove any newly added internal hardware.

 **NOTE:** Do not disconnect the AC adapter.

3. Turn on your computer.
4. When the DELL™ logo appears, press <F8> several times to access the **Advanced Boot Options** window.

 **NOTE:** If you wait too long and the operating system logo appears, continue to wait until you see the Microsoft® Windows® desktop; then, shut down your computer and try again.

5. Select **Repair Your Computer**.

6. Select **Dell DataSafe Restore and Emergency Backup** from the **System Recovery Options** menu and follow the instructions on the screen.

 **NOTE:** The restoration process may take an hour or more depending on the size of the data to be restored.

 **NOTE:** For more information, see the knowledge base article 353560 at [support.dell.com](http://support.dell.com).

## Upgrading to Dell DataSafe Local Backup Professional

 **NOTE:** Dell DataSafe Local Backup Professional may be installed on your computer, if you ordered it at the time of purchase.

Dell DataSafe Local Backup Professional provides additional features that allow you to:

- Backup and restore your computer based on file types
- Backup files to a local storage device
- Schedule automated backups

To upgrade to Dell DataSafe Local Backup Professional:

1. Double-click the Dell DataSafe Local Backup icon  on the taskbar.
2. Click **UPGRADE NOW!**
3. Follow the instructions on the screen to complete the upgrade.

## System Recovery Media

 **CAUTION:** Although the system recovery media is designed to preserve the data files on your computer, it is recommended that you backup your data files before using the system recovery media.

You can use the system recovery media, created using Dell DataSafe Local Backup, to return your hard drive to the operating state it was in when you purchased the computer while preserving the data files on your computer.

Use the system recovery media in case of:

- Operating system failure that prevents the use of recovery options that are installed on your computer.
- Hard drive failure that prevents data from being recovered.

## Restoring Your Operating System

To restore the factory image of your computer using the system recovery media:

1. Insert the system recovery disc or USB key and restart the computer.
2. When the DELL™ logo appears, press <F12> immediately.

 **NOTE:** If you wait too long and the operating system logo appears, continue to wait until you see the Microsoft® Windows® desktop; then, shut down your computer and try again.

3. Select the appropriate boot device from the list and press <Enter>.
4. Follow the instructions on the screen to complete the recovery process.

## Dell Factory Image Restore



**CAUTION:** Using Dell Factory Image Restore permanently deletes all data on the hard drive and removes any programs or drivers installed after you received your computer. If possible, back up the data before using this option. Use Dell Factory Image Restore only if System Restore did not resolve your operating system problem.



**NOTE:** Dell Factory Image Restore may not be available in certain countries or on certain computers.



**NOTE:** If Dell Factory Image Restore is not available on your computer, use Dell DataSafe Local Backup (see “Dell DataSafe Local Backup” on page 65) to restore your operating system.

You can use Dell Factory Image Restore only as the last method to restore your operating system. This option restores your hard drive to the operating state it was in when you purchased the computer. Any programs or files added since you received your computer—including data files—are permanently deleted from the hard drive. Data files include documents, spreadsheets, e-mail messages, digital photos, music files, and so on. If possible, back up all data before using Dell Factory Image Restore.

## Starting Dell Factory Image Restore

1. Turn on the computer.
2. When the DELL™ logo appears, press <F8> several times to access the **Advanced Boot Options** window.

 **NOTE:** If you wait too long and the operating system logo appears, continue to wait until you see the Microsoft® Windows® desktop; then, shut down your computer and try again.

3. Select **Repair Your Computer**. The **System Recovery Options** window appears.
4. Select a keyboard layout and click **Next**.

## Restoring Your Operating System

5. To access the recovery options, log on as a local user. To access the command prompt, type `administrator` in the **User name** field, then click **OK**.

6. Click **Dell Factory Image Restore**. The **Dell Factory Image Restore** welcome screen appears.

 **NOTE:** Depending upon your configuration, you may need to select **Dell Factory Tools**, then **Dell Factory Image Restore**.

7. Click **Next**. The **Confirm Data Deletion** screen appears.

 **NOTE:** If you do not want to proceed with Dell Factory Image Restore, click **Cancel**.

8. Select the check box to confirm that you want to continue reformatting the hard drive and restoring the system software to the factory condition, then click **Next**.

The restore process begins and may take five or more minutes to complete. A message appears when the operating system and factory-installed applications have been restored to factory condition.

9. Click **Finish** to restart the computer.





# Getting Help

If you experience a problem with your computer, you can complete the following steps to diagnose and troubleshoot the problem:

1. See “Solving Problems” on page 46 for information and procedures that pertain to the problem your computer is experiencing.
2. See the *Dell Technology Guide* available on your hard drive or at **support.dell.com/manuals** for more troubleshooting information.
3. See “Dell Diagnostics” on page 59 for procedures on how to run Dell Diagnostics.
4. Fill out the “Diagnostic Checklist” on page 76.
5. Use Dell’s extensive suite of online services available at Dell Support (**support.dell.com**) for help with installation and troubleshooting procedures. See “Online Services” on page 73 for a more extensive list of Dell Support online.

6. If the preceding steps have not resolved the problem, see “Before You Call” on page 76.

 **NOTE:** Call Dell Support from a telephone near or at the computer so that the support staff can assist you with any necessary procedures.

 **NOTE:** Dell’s Express Service Code system may not be available in all countries.

When prompted by Dell’s automated telephone system, enter your Express Service Code to route the call directly to the proper support personnel. If you do not have an Express Service Code, open the **Dell Accessories** folder, double-click the **Express Service Code** icon, and follow the directions.

 **NOTE:** Some of the services are not always available in all locations outside the continental U.S. Call your local Dell representative for information on availability.

## Technical Support and Customer Service

Dell's support service is available to answer your questions about Dell hardware. Our support staff use computer-based diagnostics to provide fast, accurate answers.

To contact Dell's support service, see "Before You Call" on page 76 and then see the contact information for your region or go to **[support.dell.com](http://support.dell.com)**.

## DellConnect

DellConnect™ is a simple online access tool that allows a Dell service and support associate to access your computer through a broadband connection, diagnose your problem, and repair it all under your supervision. For more information, go to **[www.dell.com/dellconnect](http://www.dell.com/dellconnect)**.

## Online Services

You can learn about Dell products and services on the following websites:

- **www.dell.com**
- **www.dell.com/ap** (Asian/Pacific countries only)
- **www.dell.com/jp** (Japan only)
- **www.euro.dell.com** (Europe only)
- **www.dell.com/la** (Latin American and Caribbean countries)
- **www.dell.ca** (Canada only)

You can access Dell Support through the following websites and e-mail addresses:

### Dell Support websites

- **support.dell.com**
- **support.jp.dell.com** (Japan only)
- **support.euro.dell.com** (Europe only)
- **supportapj.dell.com** (Asia Pacific only)

### Dell Support e-mail addresses

- **mobile\_support@us.dell.com**
- **support@us.dell.com**
- **la-techsupport@dell.com** (Latin America and Caribbean countries only)
- **apsupport@dell.com** (Asian/Pacific countries only)

### Dell Marketing and Sales e-mail addresses

- **apmarketing@dell.com** (Asian/Pacific countries only)
- **sales\_canada@dell.com** (Canada only)

### Anonymous file transfer protocol (FTP)

- **ftp.dell.com**

Log in as user: `anonymous`, and use your e-mail address as your password.

## Automated Order-Status Service

To check on the status of any Dell products that you have ordered, you can go to **support.dell.com**, or you can call the automated order-status service. A recording prompts you for the information needed to locate and report on your order.

If you have a problem with your order, such as missing parts, wrong parts, or incorrect billing, contact Dell for customer assistance. Have your invoice or packing slip handy when you call.

For the telephone number to call for your region, see “Contacting Dell” on page 77.

## Product Information



If you need information about additional products available from Dell, or if you would like to place an order, visit **www.dell.com**. For the telephone number to call for your region or to speak to a sales specialist, see “Contacting Dell” on page 77.

## Returning Items for Repair Under Warranty or for Credit

Prepare all items being returned, whether for repair or credit, as follows:

 **NOTE:** Before you return the product to Dell, make sure to back up any data on the hard drive and on any other storage device in the product. Remove any and all confidential, proprietary and personal information, as well as removable media, such as CDs and ExpressCards. Dell is not responsible for any of your confidential, proprietary or personal information; lost or corrupted data; or damaged or lost removable media that may be included with your return.

1. Call Dell to obtain a Return Material Authorization Number, and write it clearly and prominently on the outside of the box. For the telephone number to call for your region, see “Contacting Dell” on page 77.

2. Include a copy of the invoice and a letter describing the reason for the return.
  3. Include a copy of the Diagnostics Checklist (see “Diagnostic Checklist” on page 76), indicating the tests that you have run and any error messages reported by the Dell Diagnostics (see “Dell Diagnostics” on page 59).
  4. Include any accessories that belong with the item(s) being returned (power cables, software, guides, and so on) if the return is for credit.
  5. Pack the equipment to be returned in the original (or equivalent) packing materials.
-  **NOTE:** You are responsible for paying shipping expenses. You are also responsible for insuring any product returned, and you assume the risk of loss during shipment to Dell. Collect On Delivery (C.O.D.) packages are not accepted.
-  **NOTE:** Returns that are missing any of the preceding requirements will be refused at Dell’s receiving dock and returned to you.

## Before You Call

 **NOTE:** Have your Express Service Code ready when you call. The code helps Dell's automated-support telephone system direct your call more efficiently. You may also be asked for your Service Tag (located on the bottom of your computer).

Remember to fill out the following Diagnostics Checklist. If possible, turn on your computer before you call Dell for assistance and call from a telephone at or near the computer. You may be asked to type some commands at the keyboard, relay detailed information during operations, or try other troubleshooting steps possible only at the computer itself. Ensure that the computer documentation is available.

### Diagnostic Checklist

- Name:
- Date:
- Address:
- Phone number:
- Service Tag (bar code on the back or bottom of the computer):
- Express Service Code:
- Return Material Authorization Number (if provided by Dell support technician):
- Operating system and version:
- Devices:
- Expansion cards:
- Are you connected to a network? Yes/No
- Network, version, and network adapter:
- Programs and versions:

See your operating system documentation to determine the contents of the computer's start-up files. If the computer is connected to a printer, print each file. Otherwise, record the contents of each file before calling Dell.

- Error message, beep code, or diagnostic code:
- Description of problem and troubleshooting procedures you performed:

## Contacting Dell

For customers in the United States, call 800-WWW-DELL (800-999-3355).

 **NOTE:** If you do not have an active Internet connection, you can find contact information on your purchase invoice, packing slip, bill, or Dell product catalog.

Dell provides several online and telephone-based support and service options. Availability varies by country and product, and some services may not be available in your area.

To contact Dell for sales, technical support, or customer service issues:

1. Visit **[support.dell.com/contactdell](https://support.dell.com/contactdell)**.
2. Select your country or region.
3. Select the appropriate service or support link based on your requirement.
4. Choose the method of contacting Dell that is convenient for you

# Finding More Information and Resources

## If you need to:

---

reinstall your operating system

---

run a diagnostic program for your computer

---

reinstall system software

---

find more information about the Microsoft®  
Windows® operating system and features

---

upgrade your computer with new or additional  
memory, or a new hard drive

---

reinstall or replace a worn or defective part

## See:

---

“System Recovery Media” on page 67

---

“Dell Diagnostics” on page 59

---

“My Dell Downloads” on page 56

---

**support.dell.com**

---

the *Service Manual* at  
**support.dell.com/manuals**



**NOTE:** In some countries, opening and replacing parts of your computer may void your warranty. Check your warranty and return policies before working inside your computer.

---



### If you need to:

---

find safety best practices information for your computer

review Warranty information, Terms and Conditions (U.S. only), Safety instructions, Regulatory information, Ergonomics information, and End User License Agreement

---

find your Service tag/Express Service Code — You must use the service tag to identify your computer on **support.dell.com** or to contact technical support

---

find drivers and downloads; readme files  
access technical support and product help  
check on your order status for new purchases

find solutions and answers to common questions

locate information for last-minute updates about technical changes to your computer or advanced technical-reference material for technicians or experienced users

---

### See:

---

the safety and regulatory documents that shipped with your computer and also see the Regulatory Compliance Homepage at **[www.dell.com/regulatory\\_compliance](http://www.dell.com/regulatory_compliance)**

---



the bottom of your computer  
the **Dell Support Center**. To launch the **Dell Support Center**, click the  icon in the taskbar

---

**[support.dell.com](http://support.dell.com)**

# Specifications

This section provides information that you may need when setting up, updating drivers for, and upgrading your computer.

 **NOTE:** Offerings may vary by region. For more information regarding the configuration of your computer, click **Start**  → **Help and Support** and select the option to view information about your computer.

## Computer Model

---

Dell Studio 1745/1747/1749

## Computer Information

---

System chipset	Mobile Intel Express GM45 (Studio 1745)
	Mobile Intel 5 Series Discrete GFX (Studio 1745)
	Mobile Intel 5 Series Express chipset PM55 (Studio 1747)
	Mobile Intel 5 Series Express chipset HM55 (Studio 1749)

## Computer Information

---

Data bus width	64 bits
DRAM bus width	dual-channel (2) 64-bit buses
Processor address bus width	32 bits
Flash EPROM	2 MB (Studio 1745 and 1747) 4 MB (Studio 1749)
Graphics bus	PCI-E x16

<b>Computer Model</b>	<b>Studio 1745</b>	<b>Studio 1747</b>	<b>Studio 1749</b>
<b>Processor</b>			
Processor type	Intel® Celeron® Intel Pentium® Dual-Core Intel Core™2 Duo	Intel Core i7 (Quad-Core)	Intel Core i3 Intel Core i5 Intel Core i7 (Dual-Core)
L1 cache	64 KB (32 KB for each core)	256 KB (64 KB for each core)	128 KB (64 KB for each core)
L2 cache	2 MB or 3 MB or 6 MB (Intel Core2 Duo) 1 MB (Intel Celeron and Intel Pentium Dual-Core)	1 MB (256 KB for each core)	512 KB (256 KB for each core)
L3 cache		up to 8 MB of shared data	up to 4 MB of shared data

## Specifications

<b>Computer Model</b>	<b>Studio 1745</b>	<b>Studio 1747</b>	<b>Studio 1749</b>
<b>Video</b>			
LCD interface	Low Voltage Differential Signaling (LVDS)	LVDS	LVDS
TV support	HDMI 1.3	HDMI 1.3	HDMI 1.3
Discrete			
Video type	integrated on system board	integrated on system board	integrated on system board
Video controller	ATI Mobility Radeon HD 4570/4650	ATI Mobility Radeon HD 4650	ATI Mobility Radeon HD 5650
Video memory	DDR3 512 MB/1 GB	DDR3 1 GB	DDR3 1 GB

<b>Computer Model</b>	<b>Studio 1745</b>	<b>Studio 1747</b>	<b>Studio 1749</b>
UMA			
Video type	integrated on system board		integrated on system board
Video controller	Mobile Intel GMA 4500MHD		Intel GMA HD
Video memory	up to 358 MB of shared memory		up to 1.7 GB of shared memory

## Specifications

### Memory

---

Memory module connector	two user-accessible SODIMM connectors
Memory module capacities	1 GB, 2 GB, 3 GB, 4 GB, 5 GB, 6 GB, and 8 GB
Memory type	1066 MHz SODIMM DDR3 (Studio 1745/1747/1749) 1333 MHz SODIMM DDR3 (Studio 1747)
Minimum memory configuration	1 GB
Maximum memory configuration	8 GB

 **NOTE:** For instructions on upgrading memory, see the *Service Manual* at [support.dell.com/manuals](http://support.dell.com/manuals).

### ExpressCard

---

ExpressCard controller	Intel ICH9M (Studio 1745) Mobile Intel 5 Series Express chipset PM55 (Studio 1747) Mobile Intel 5 Series Express chipset HM55 (Studio 1749)
Cards supported	ExpressCard/34 (34 mm) 1.5 V and 3.3 V
ExpressCard connector size	26 pins

**Connectors**

---

Audio	one microphone-in connector, two stereo headphones/speakers connectors
IEEE 1394a	one 4-pin mini, non-powered connector
Mini-Card	one Type IIIA full Mini-Card slot, two half-size Mini-Card slots
HDMI connector	one 19-pin connector
Network adapter	one RJ45 connector
USB	two four-pin USB 2.0-compliant connectors

**Connectors**

---

Video	one 15-hole connector
DisplayPort	one 20-pin connector
eSATA	one seven-pin/four-pin eSATA/USB combo connector

**Communications**

---

Modem (optional)	external V.92 56K USB modem
Controller	hardware modem
Interface	USB
Network adapter	10/100/1000 Ethernet LAN on system board
Wireless	WLAN, WWAN, WiMax/Wi-Fi abgn, and WPAN with Bluetooth® wireless technology

## Specifications

### Audio

---

Audio type	JBL 2.1 channel with SRS enhanced audio
Audio controller	IDT 92HD73C
Stereo conversion	24-bit (analog-to-digital and digital-to-analog)
Internal Interface	Intel High Definition audio
Speaker	two 1.5 watt main speakers and one 3.0 watt subwoofer, for a total system power of 6.0 watt
Volume controls	program menus and media controls

### Camera

---

Pixel	2.0 megapixel
Video resolution	160 x 120 ~1600 x 1200 (160 x 120 ~ 1280 x 720 at 30 fps)
Diagonal viewing angle	60°

### Display

---

Type	17.3" HD+ WLED backlight, TrueLife 17.3" FHD B+RG LED backlight, TrueLife
------	--



**Display**

## Dimensions:

Height	214.81 mm (8.46 inches)
Width	381.89 mm (15.04 inches)
Diagonal	439.42 mm (17.30 inches)
Maximum resolution	HD+: 1600 x 900 FHD: 1920 x 1080
Refresh rate	60 Hz
Operating angle	0° (closed) to 140°
Luminance	HD+: 220 nits (60% CG) FHD: 300 nits (92% CG)

**Display**

## Viewing Angles:

Horizontal	HD+: 40/40 FHD: 60/60 (both 72% and 90% CG)
Vertical	HD+: 15/30 (H/L) FHD: 50/50 (both 72% and 90% CG)
Pixel pitch	HD+: 0.24 x 0.24 mm FHD: 0.20 x 0.20 mm
Controls	brightness can be controlled through keyboard shortcuts (see the <i>Dell Technology Guide</i> for more information).

## Specifications

### Keyboard (Backlit)

---

Number of keys	102 (U.S. and Canada); 103 (Europe); 106 (Japan); 105 (Brazil)
Layout	QWERTY/AZERTY/Kanji

### Touch Pad

---

X/Y position resolution (graphics table mode)	240 cpi
---	---------

#### Size:

Width	100 mm (3.9 inches) sensor active area
Height	56 mm (2.2 inches) rectangle

### Battery

---

Types and dimensions:

9-cell “smart” lithium ion

Height	41.9 mm (1.65 inches)
Width	340.6 mm (13.41 inches)
Depth	56.7 mm (2.23 inches)
Weight	0.52 kg (1.15 lb)

**Battery**

---

6-cell "smart" lithium ion	
Height	22.2 mm (0.87 inches)
Width	206.0 mm (8.11 inches)
Depth	56.7 mm (2.23 inches)
Weight	0.35 kg (0.77 lb)
Voltage	11.1 VDC (6/9 cell)
Charge time (approximate):	4 hours (when the computer is turned off)

**Battery**



---

Operating time	varies depending on operating conditions and can be significantly reduced under certain power-intensive conditions.  See the <i>Dell Technology Guide</i> for more information.
Life span (approximate)	300 discharge/charge cycles
Temperature range:	
Operating	0° to 35°C (32° to 95°F)
Storage	-40° to 65°C (-40° to 149°F)
Coin-cell battery	CR-2032

## Specifications

### AC Adapter

---

 **NOTE:** Use only AC adapters specified for use with your computer. See the safety information that shipped with your computer.

Input voltage	100–240 VAC
Input current (maximum)	2.50 A
Input frequency	50–60 Hz
Output power	65 W, 90 W, or 130 W
Output current	
65 W	3.34 A (continuous)
90 W	4.62 A (continuous)
130 W	6.70 A (continuous)
Rated output voltage	19.5 ± 1 VDC

### AC Adapter

---

Dimensions:

#### 130 W (E-Series)

Height	25.4 mm (1.0 inches)
Width	76.2 mm (3.0 inches)
Depth	154.7 mm (6.1 inches)
Weight (with cables)	up to 0.74 kg (1.63 lb)

#### 90 W (E-Series)

Height	16 mm (0.6 inches)
Width	70 mm (2.8 inches)
Depth	147 mm (5.8 inches)
Weight (with cables)	up to 0.53 kg (1.17 lb)

**AC Adapter**

## 90 W (D-Series)

Height	34.2 mm (1.3 inches)
Width	60.8 mm (2.3 inches)
Depth	153.4 mm (6.0 inches)
Weight (with cables)	up to 0.70 kg (1.54 lb)

## 65 W (Auto Air Adapter)

Height	15 mm (0.5 inches)
Width	66 mm (2.6 inches)
Depth	127 mm (5.0 inches)
Weight (with cables)	up to 0.53 kg (1.17 lb)

**AC Adapter**

## Temperature range:

Operating	0° to 40°C (32° to 104°F)
Storage	-40° to 70°C (-40° to 158°F)

**Physical**

Height	28 mm to 40 mm (1.10 inches to 1.57 inches)
Width	413.0 mm (16.26 inches)
Depth	280.5 mm (11.04 inches)
Weight (with 6-cell battery)	configurable to less than 3.3 kg (7.27 lbs)

## Specifications

### Computer Environment

---

Temperature range:

Operating	0° to 35°C (32° to 95°F)
Storage	-40° to 65°C (-40° to 149°F)

Relative humidity (maximum):

Operating	10% to 90% (noncondensing)
Storage	5% to 95% (noncondensing)

Maximum vibration (using a random vibration spectrum that simulates user environment):

Operating	0.66 GRMS
Non-Operating	1.30 GRMS

### Computer Environment

---

Maximum shock (for operating — measured with Dell Diagnostics running on the hard drive and a 2-ms half-sine pulse; for non-operating — measured with the hard drive in head-parked position and a 2-ms half-sine pulse):

Operating	110 G
Non-Operating	160 G

Altitude (maximum):

Operating	-15.2 to 3048 m (-50 to 10,000 ft)
Storage	-15.2 to 10,668 m (-50 to 35,000 ft)

Airborne contaminant level	G2 or lower as defined by ISA-S71.04-1985
----------------------------	---

# Appendix

## Macrovision Product Notice

This product incorporates copyright protection technology that is protected by method claims of certain U.S. patents and other intellectual property rights owned by Macrovision Corporation and other rights owners. Use of this copyright protection technology must be authorized by Macrovision Corporation, and is intended for home and other limited viewing uses only unless otherwise authorized by Macrovision Corporation. Reverse engineering or disassembly is prohibited.

## Information for NOM, or Official Mexican Standard (Only for Mexico)

The following information is provided in the device(s) described in this document in accordance with the requirements of the Official Mexican Standard (NOM):

**Importer:**

Dell México S.A. de C.V.

Paseo de la Reforma 2620 - 11°

Col. Lomas Altas

11950 México, D.F.

<b>Regulatory model number</b>	<b>Voltage</b>	<b>Frequency</b>	<b>Electricity consumption</b>	<b>Output voltage</b>	<b>Output intensity</b>
P02E	100–240 VAC	50–60 Hz	1.50/1.60/1.70/ 2.30/2.50 A	19.5 VDC	3.34/4.62/6.70 A

For details, read the safety information that shipped with your computer.

For additional safety best practices information, see the Regulatory Compliance Homepage at [www.dell.com/regulatory\\_compliance](http://www.dell.com/regulatory_compliance).



# Index

## A

airflow, allowing **5**

## C

calling Dell **76**

computer capabilities **42**

computer, setting up **5**

connect(ing)

    to the Internet **16**

Contacting Dell online **77**

customer service **72**

## D

damage, avoiding **5**

DellConnect **72**

Dell Diagnostics **59**

Dell Factory Image Restore **68**

Dell Support Center **55**

Dell Touch Zone **36**

Diagnostic Checklist **76**

DisplayPort connector **25**

drivers and downloads **79**

DVDs, playing and creating **43**

## E

email addresses

    for technical support **73**

## F

finding more information **78**

FTP login, anonymous **73**

## G

gestures

touch pad **30**

touch screen **38**

## H

hardware problems

diagnosing **58**

Hardware Troubleshooter **58**

help

getting assistance and support **71**

## I

Internet connection **16**

ISP

Internet Service Provider **16**

## M

memory problems

solving **52**

## N

network connection

fixing **49**

## P

power problems, solving **50**

power strips, using **6**

problems, solving **46**

products

information and purchasing **74**

## R

resources, finding more **78**

restoring factory image **68**

**S**

setup, before you begin **5**

shipping products

    for return or repair **75**

SIM **12**

software features **42**

software problems **52**

solving problems **46**

specifications **80**

support email addresses **73**

support sites

    worldwide **73**

System Messages **56**

system reinstall options **63**

**U**

USB PowerShare **26**

**V**

ventilation, ensuring **5**

**W**

warranty returns **75**

Windows **9**

    Program Compatibility Wizard **53**

    reinstall **63**

wired network

    network cable, connecting **7**

wireless network connection **49**







Printed in the U.S.A.

[www.dell.com](http://www.dell.com) | [support.dell.com](http://support.dell.com)



OGYVXHA00